

Electromagnetic Lock Installation Instruction Guide (Intend for use in indoor dry location)

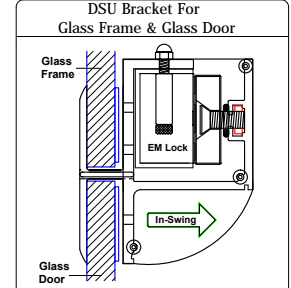

Model	300-S
Spec	
Holding Force	Up to 300 lbs (Factory Tested)**
Voltage Input	12VDC / 24VDC *
Current Draw	300mA / 150mA
Dimension	(L)170 x (W)35 x (T)22 (mm)

Basic Installation Concept & Accessories

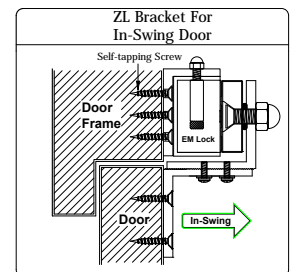
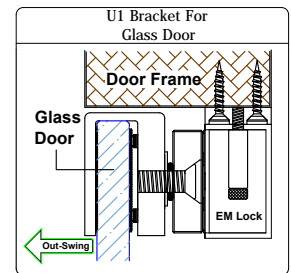
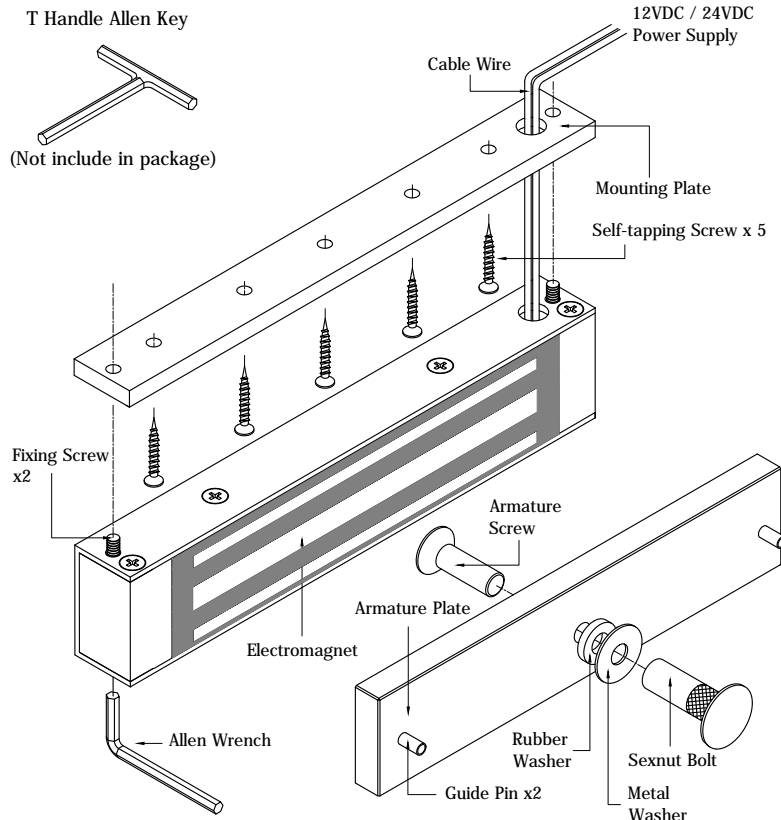
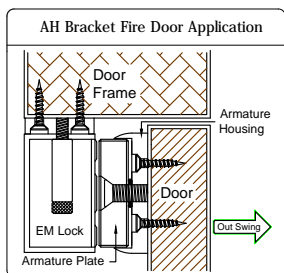
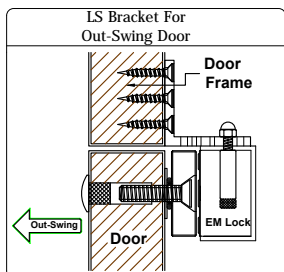
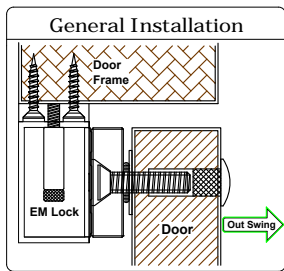

General Installation Steps & Maintenance

1. Fold the installation template provided along the dotted line upto 90°.
2. Close the door & position the template at the lock jamb side of the frame with a gap 10mm.
3. Mark & drill holes according to template indications.
4. Install the Armature Plate to the door.
5. Loosely tighten screw through the adjustable slot on mounting plate to the door frame as indicated on installation template.
6. Make sure the mounting plate & armature align properly, then screw in the balance mounting screws.
7. Use allen wrench to unscrew anti tamper nut and install the lock by tighten the fixing screws on the mounting plate. Pull cable wire through frame to lock housing.
8. Screw in the anti-tamper nuts to prevent unauthorized access and make sure to fully tighten the fixing screw with proper tool "T" Handle Allen Key.
9. Connect the power wires accordance with NFPA 101 & all wiring to be completed inside protect area.
10. Typical wiring method which shall be in accordance with CSA C22.1, Canadian Electrical Code, Part I, Safety Standard for Electrical Installations, Section 32.
11. It is recommended that to apply a light coat of silicon lubricant to the mating surface on a monthly basis to prevent rust.

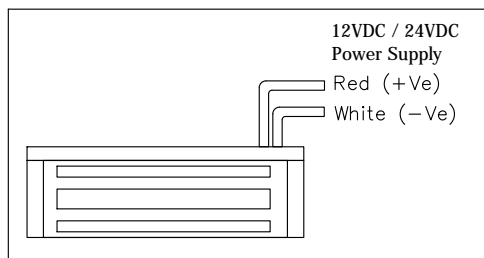

Wiring Instruction

* Note: 12VDC / 24VDC is pre-set upon manufacture; once it set, it cannot be changed.

Notice:
Model are Recognized to:
UL 294 : Standard for Access Control System Units, 6th Ed.
ULC S533-15: Standard for Egress Door Securing & Releasing Devices, 4th Ed.

** Value not verified by UL.

Remark: All drawing shown are for illustration purpose only.
Actual product may vary due to product enhancement.

Trouble Shooting

1. Sensor not functioning
 - Improper attachment of electromagnet and armature plate
 - Modification of the PCB
2. Door not locked
 - Incorrect wiring or no power from power supply
3. Reduced holding force
 - Poor contact of electromagnet and armature.
 - Be sure armature is loose enough that it can fully contact electromagnet along the entire length.
 - Mating surface is dusty or damaged.
 - Improper input voltage or wire size.

Performance Level

- Destructive Attack: Level I
- Line Security: Level I
- Standby Power: Level I
- Endurance 250,000 Cycles: Level IV (Relay Source #2 & #3)

Copyright © E.I.S.B. All Right Reserved.
EISB-EMS-IG Ver.A Publish:06.3.2020

Basic Bracket Installation Guide

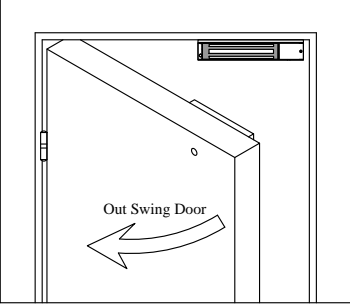

Out Swing Door

1

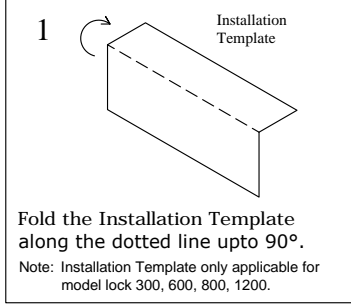

Installation Template

Fold the Installation Template along the dotted line upto 90°.

Note: Installation Template only applicable for model lock 300, 600, 800, 1200.

2

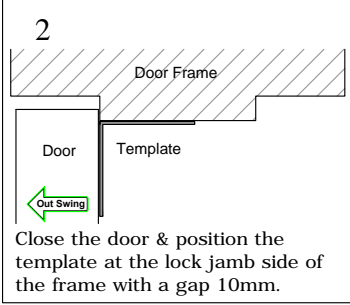

Door Frame

Door

Close the door & position the template at the lock jamb side of the frame with a gap 10mm.

3

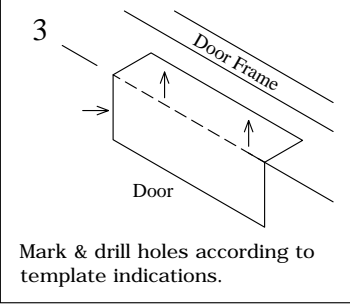

Door Frame

Door

Mark & drill holes according to template indications.

4

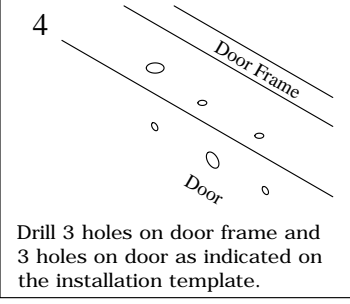

Door Frame

Door

Drill 3 holes on door frame and 3 holes on door as indicated on the installation template.

5

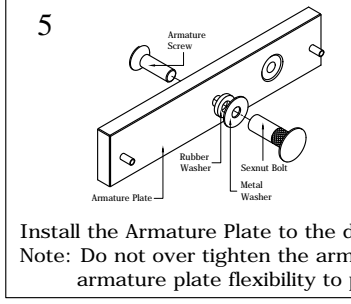

Armature Screw

Rubber Washer

Seam Bolt

Metal Washer

Armature Plate

Wooden Door

Door

Install the Armature Plate to the door.

Note: Do not over tighten the armature screw which would affect the armature plate flexibility to pivot around the screw.

6

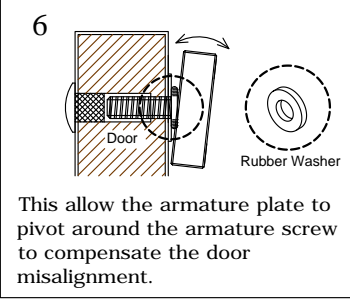

Door

Rubber Washer

This allow the armature plate to pivot around the armature screw to compensate the door misalignment.

7

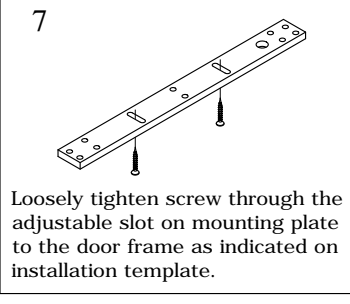

Loosely tighten screw through the adjustable slot on mounting plate to the door frame as indicated on installation template.

8

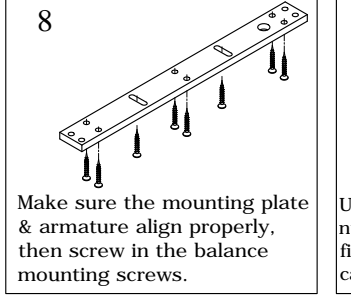

Make sure the mounting plate & armature align properly, then screw in the balance mounting screws.

9

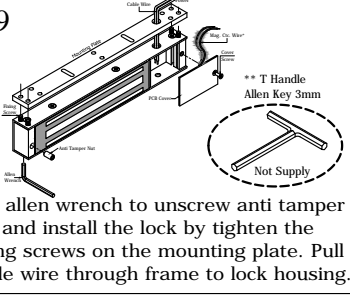

Use allen wrench to unscrew anti tamper nut and install the lock by tighten the fixing screws on the mounting plate. Pull cable wire through frame to lock housing.

** T Handle Allen Key 3mm

Not Supply

10

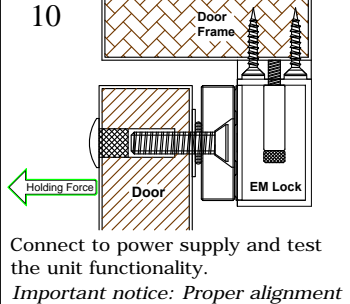

Door Frame

Door

EM Lock

Connect to power supply and test the unit functionality.

Important notice: Proper alignment between magnet & armature plate is important for the lock operate normally.

ZL Bracket for In-Swing Door Installation Guide

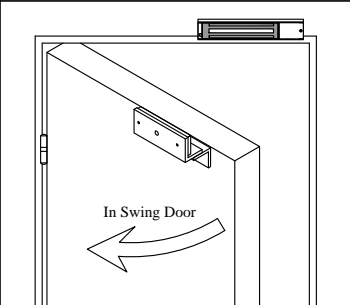

In Swing Door

1

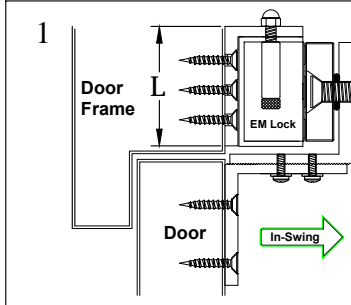

Door Frame

Door

In-Swing

The door frame min. height value "L" is needed to accommodate the bracket

Model:

- 300ZL(L) = 39mm
- 600ZL(L) = 46mm
- 800ZL(L) = 52mm
- 1200ZL(L) = 73mm
- 1500ZL(L) = 76mm

2

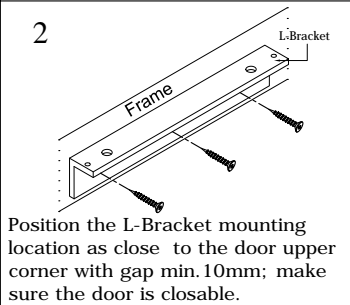

L-Bracket

Frame

Position the L-Bracket mounting location as close to the door upper corner with gap min. 10mm; make sure the door is closable.

3

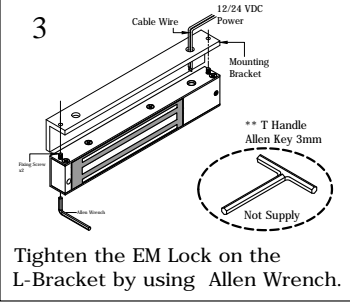

Cable Wire

12/24 VDC Power

Mounting Bracket

** T Handle Allen Key 3mm

Not Supply

Tighten the EM Lock on the L-Bracket by using Allen Wrench.

4

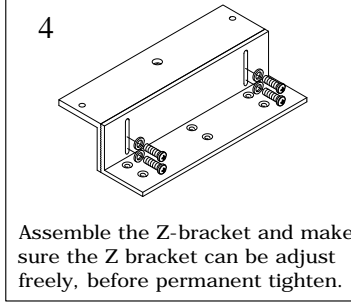

Assemble the Z-bracket and make sure the Z bracket can be adjust freely, before permanent tighten.

5

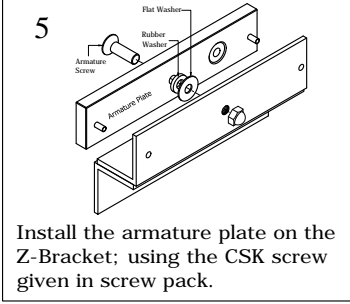

Flat Washer

Rubber Washer

Armature Plate

Install the armature plate on the Z-Bracket; using the CSK screw given in screw pack.

6

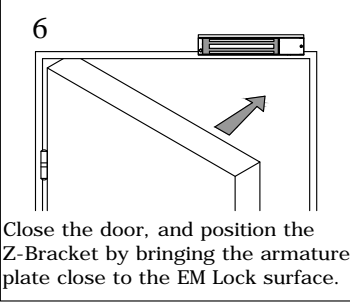

Close the door, and position the Z-Bracket by bringing the armature plate close to the EM Lock surface.

7

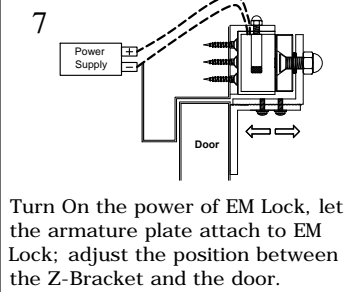

Power Supply

Door

Turn On the power of EM Lock, let the armature plate attach to EM Lock; adjust the position between the Z-Bracket and the door.

8

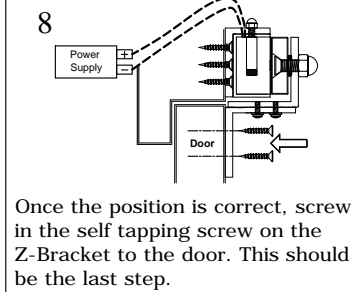

Power Supply

Door

Once the position is correct, screw in the self tapping screw on the Z-Bracket to the door. This should be the last step.

Distance in feet from power supply to the furthest lock unit

	Amps	25f	50f	75f	100f	150f	200f	250f	300f	400f	500f	1000f
	0.25	18	18	18	18	18	16	16	14	14	12	
Minimum	0.50	18	18	18	16	16	14	12				
Wire Gauge (AWG) for 12VDC	0.75	18	18	16	14	12	12					
	1.00	18	16	14	14	12						
	1.50	18	14	12	12							
	2.00	16	14	12								
	Amps	25f	50f	75f	100f	150f	200f	250f	300f	400f	500f	1000f
	0.25	18	18	18	18	18	18	18	18	16	16	16
Minimum	0.50	18	18	18	18	18	16	16	14	14	12	
Wire Gauge (AWG) for 24VDC	0.75	18	18	18	18	16	14	14	12	12		
	1.00	18	18	16	16	14	14	12	12			
	1.50	18	18	16	14	14	12					
	2.00	16	16	14	14	12						

Remark: All drawing shown are for illustration purpose only.
Actual product may vary due to product enhancement.

Copyright © E.I.S.B. All Right Reserved.
EISB-EMS-IG Ver.A Publish:06.3.2020